

CIRCUS rectangular S1000x1500 v2 1-10V 100-277V

ver. 20200404_Rev_0

year: 2015
code: 2730361S20000
type: hanging lamp
application: indoor

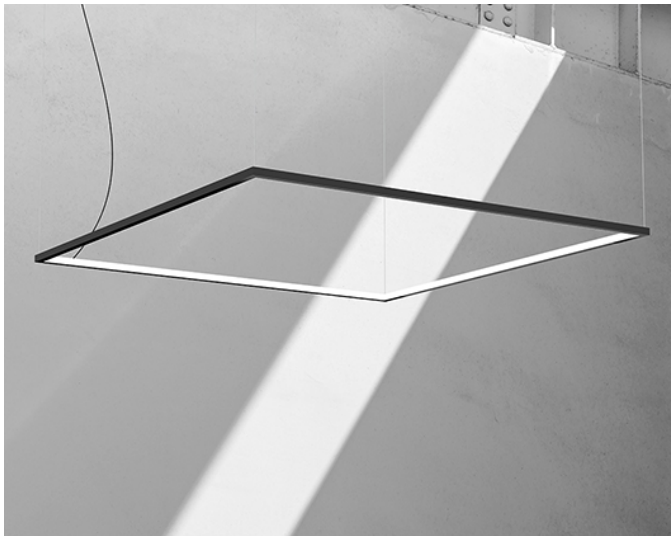
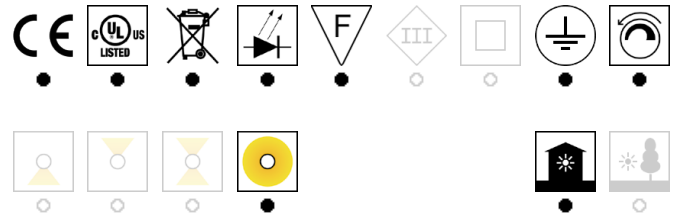

Technical drawing

Size ref. image mm - inch

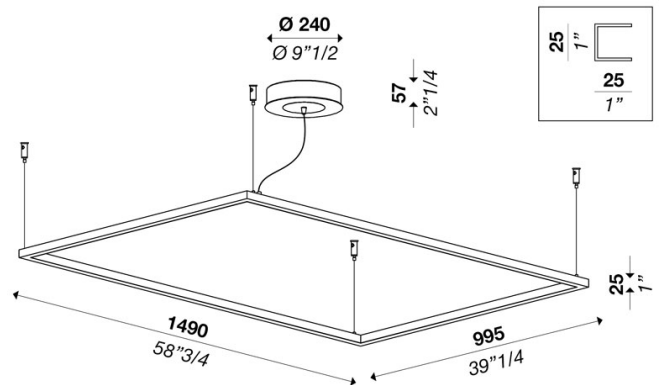

Technical data

Light source	LED
Circuit structure	LED strip
Light emission direction	diffused
Power	110 W
Source lumens	15400 lm
Source efficacy	140 lm/W
Consumption	122 W
Delivered lumens	11100 lm
Luminaire efficacy	91 lm/W
Secondary	24 V
Colour temperature	3000 K / variants page 2
Colour rendering index	80 CRI / variants page 2
Standard Deviation of Colour Matching	3 SDCM
Energy class	A
Safety class	I
Degree of protection	IP 20
Direct mounting on normally flammable surfaces	●
Operating temperature	+10° / +40°
CE	●
UL	●

Optional

Emergency mode	○
Motion sensor	○
Directional	○

Packing

Net weight	
Packaging 1	
Packaging 2	
Packaging 3	
Packaging 4	
Packaging 5	

Structure

Material	aluminium
Finish	white / variants page 2

Diffuser

Material	polycarbonate
Finish	opal / variants page 2

Canopy

Size	240 mm - 9" 1/2 inch
Height	57 mm - 2" 1/4 inch
Ceiling mount	perpendicular / variants page 2

Electronics / Driver

Included	Yes
Quantity	2
Voltage	100-277V 50/60 Hz

Dimmable



Hanging cables

Stainless steel cables standard length (custom available)	2000 mm / 78" 3/4
Electric cable standard length (custom available)	2500 mm/100"

Warranty

Duration	2 years
----------	---------

CIRCUS rectangular S1000x1500 v2 1-10V 100-277V

ver. 20200404_Rev_0

year: **2015**
code: **2730361S20000**
type: **hanging lamp**
application: **indoor**

Available variants

Colour temperature

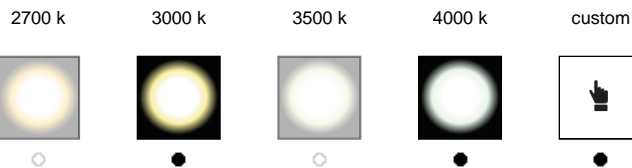

Colour rendering index

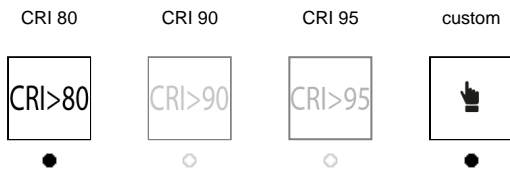

Structure finish

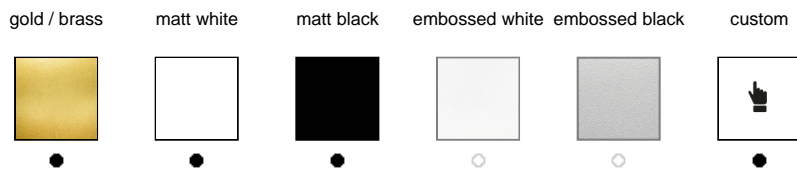

Diffuser / Optical

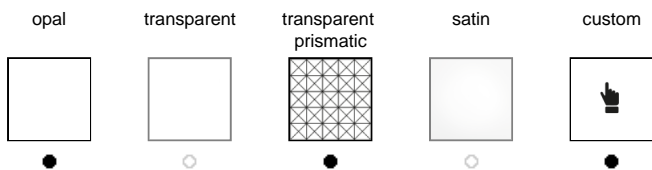

Ceiling Mount

