

CIRCUS square S1500 v2 DALI 100-277V

ver. 20200404_Rev_0

year: 2015
code: 2730351S10000
type: hanging lamp
application: indoor

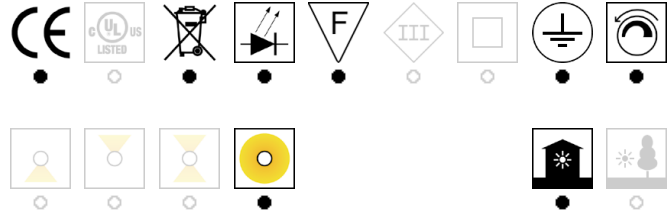

Technical drawing
Size ref. image mm - inch

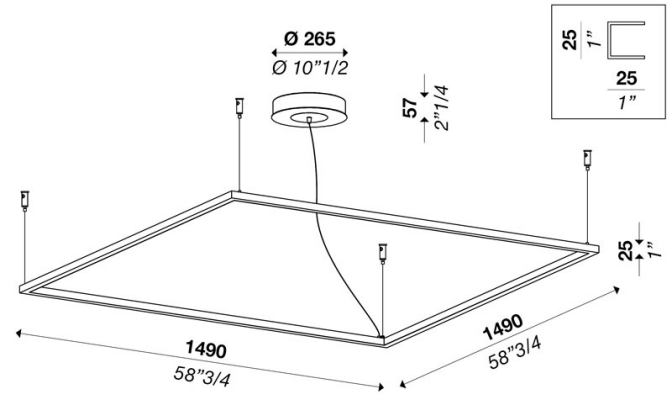

Technical data

Light source	LED
Circuit structure	LED strip
Light emission direction	diffused
Power	138 W
Source lumens	19320 lm
Source efficacy	140 lm/W
Consumption	150 W
Delivered lumens	14048 lm
Luminaire efficacy	94 lm/W
Secondary	24 V
Colour temperature	3000 K / variants page 2
Colour rendering index	80 CRI / variants page 2
Standard Deviation of Colour Matching	3 SDCM
Energy class	A
Safety class	I
Degree of protection	IP 20
Direct mounting on normally flammable surfaces	●
Operating temperature	+10° / +40°
CE	●
UL	○

Optional

Emergency mode	○
Motion sensor	○
Directional	○

Packing

Net weight	
Packaging 1	
Packaging 2	
Packaging 3	
Packaging 4	
Packaging 5	

Structure

Material	aluminium
Finish	white / variants page 2

Diffuser

Material	polycarbonate
Finish	opal / variants page 2

Canopy

Diameter (Ø)	265 mm - 10" 1/2 inch
Height	57 mm - 2" 1/4 inch
Ceiling mount	perpendicular / variants page 2

Electronics / Driver

Included	Yes
Quantity	2
Voltage	100-277V 50/60 Hz

Dimmable



Hanging cables

Stainless steel cables standard length (custom available)	2000 mm / 78" 3/4
Electric cable standard length (custom available)	2500 mm/100"

Warranty

Duration	2 years
----------	---------

CIRCUS square S1500 v2 DALI 100-277V

ver. 20200404_Rev_0





year: **2015**
code: **2730351S10000**
type: **hanging lamp**
application: **indoor**

Available variants

Colour temperature

2700 k	3000 k	3500 k	4000 k	bulb	custom
					
<input type="radio"/>	<input checked="" type="radio"/>	<input type="radio"/>	<input type="radio"/>	<input type="radio"/>	<input type="radio"/>







Colour rendering index

CRI 80	CRI 90	CRI 95	custom
			
<input type="radio"/>	<input type="radio"/>	<input type="radio"/>	<input checked="" type="radio"/>





Structure finish

gold / brass	champagne	gunmetal	beige	lead	naval brass	anodized brass	glossy night blue	sideral copper	blue 5020
									
<input checked="" type="radio"/>	<input type="radio"/>	<input type="radio"/>	<input type="radio"/>	<input type="radio"/>	<input type="radio"/>	<input type="radio"/>	<input type="radio"/>	<input type="radio"/>	<input type="radio"/>
matt white	matt black	embossed white	embossed black	titanium	manganese	ferrari red	mat blue	bronze	custom
									
<input checked="" type="radio"/>	<input type="radio"/>	<input type="radio"/>	<input type="radio"/>	<input type="radio"/>	<input type="radio"/>	<input type="radio"/>	<input type="radio"/>	<input type="radio"/>	<input type="radio"/>

Diffuser / Optical

opal	opal prismatic	transparent	transparent prismatic	satin	custom
					
<input type="radio"/>	<input type="radio"/>	<input type="radio"/>	<input checked="" type="radio"/>	<input type="radio"/>	<input type="radio"/>

Ceiling Mount

direct	perpendicular	conical	remote driver	custom
				
<input type="radio"/>	<input checked="" type="radio"/>	<input type="radio"/>	<input type="radio"/>	<input type="radio"/>