

CIRCUS multiround v2 DALI 100-277V

ver. 20200404_Rev_0

year: 2015
code: 2730340S10000
type: hanging lamp
application: indoor

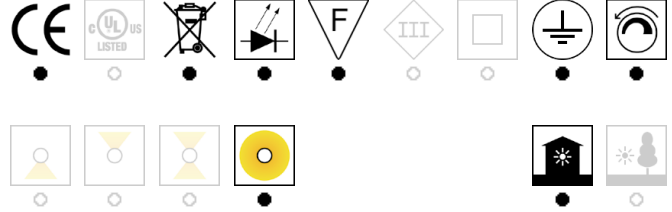

Technical drawing
Size ref. image mm - inch

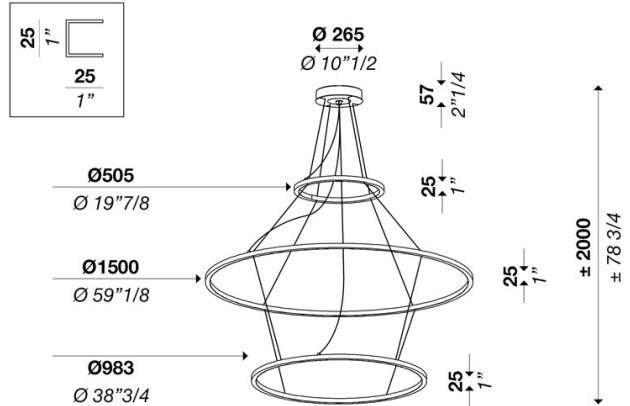

Technical data	
Light source	LED
Circuit structure	LED strip
Light emission direction	diffused
Power	219 W
Source lumens	30660 lm
Source efficacy	140 lm/W
Consumption	247 W
Delivered lumens	12632 lm
Luminaire efficacy	51 lm/W
Secondary	24 V
Colour temperature	3000 K / variants page 2
Colour rendering index	80 CRI / variants page 2
Standard Deviation of Colour Matching	3 SDCM
Energy class	A
Safety class	I
Degree of protection	IP 20
Direct mounting on normally flammable surfaces	●
Operating temperature	+10° / +40°
CE	●
UL	○
Optional	
Emergency mode	○
Motion sensor	○
Directional	○
Packing	
Net weight	
Packaging 1	L4200 x W4200 x H230 mm / 3.60 kg
Packaging 2	L1610 x W1640 x H150 mm / 11.80 kg
Packaging 3	
Packaging 4	
Packaging 5	

Structure						
Material	aluminium					
Finish	white / variants page 2					
Diffuser						
Material	polycarbonate					
Finish	opal / variants page 2					
Canopy						
Diameter (Ø)	265 mm - 10" 1/2 inch					
Height	57 mm - 2" 1/4 inch					
Ceiling mount	conical / variants page 2					
Electronics / Driver						
Included	Yes					
Quantity	2					
Voltage	100-277V 50/60 Hz					
Dimmable						
ON/OFF	PUSH	0-10V	1-10V	CUT PHASE	Bluetooth	DALI
○	○	○	○	○	○	●
Hanging cables						
Stainless steel cables standard length (custom available)	2000 mm / 78" 3/4					
Electric cable standard length (custom available)	2500 mm/100"					
Warranty						
Duration	2 years					

CIRCUS multiround v2 DALI 100-277V

ver. 20200404_Rev_0





year: **2015**
code: **2730340S10000**
type: **hanging lamp**
application: **indoor**

Available variants











Colour temperature

2700 k	3000 k	3500 k	4000 k	bulb	custom
					
<input type="radio"/>	<input checked="" type="radio"/>	<input type="radio"/>	<input type="radio"/>	<input type="radio"/>	<input type="radio"/>







Colour rendering index

CRI 80	CRI 90	CRI 95	custom
			
<input type="radio"/>	<input type="radio"/>	<input type="radio"/>	<input type="radio"/>





Structure finish

gold / brass	champagne	gunmetal	beige	lead	naval brass	anodized brass	glossy night blue	sideral copper	blue 5020
									
<input checked="" type="radio"/>	<input type="radio"/>	<input type="radio"/>	<input type="radio"/>	<input type="radio"/>	<input type="radio"/>	<input type="radio"/>	<input type="radio"/>	<input type="radio"/>	<input type="radio"/>
matt white	matt black	embossed white	embossed black	titanium	manganese	ferrari red	mat blue	bronze	custom
									
<input checked="" type="radio"/>	<input type="radio"/>	<input type="radio"/>	<input type="radio"/>	<input type="radio"/>	<input type="radio"/>	<input type="radio"/>	<input type="radio"/>	<input type="radio"/>	<input type="radio"/>

Diffuser / Optical

opal	opal prismatic	transparent	transparent prismatic	satin	custom
					
<input type="radio"/>	<input type="radio"/>	<input type="radio"/>	<input type="radio"/>	<input type="radio"/>	<input type="radio"/>

Ceiling Mount

direct	perpendicular	conical	remote driver	custom
				
<input type="radio"/>	<input type="radio"/>	<input type="radio"/>	<input type="radio"/>	<input type="radio"/>