

CIRCUS round S1500 v2 DALI 100-277V

ver. 20200404_Rev_0

year: **2015**
code: **2730331S10100**
type: **hanging lamp**
application: **indoor**

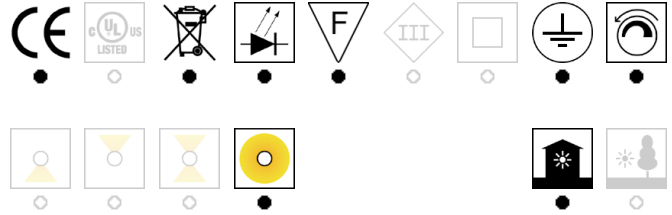

Technical drawing

Size ref. image mm - inch

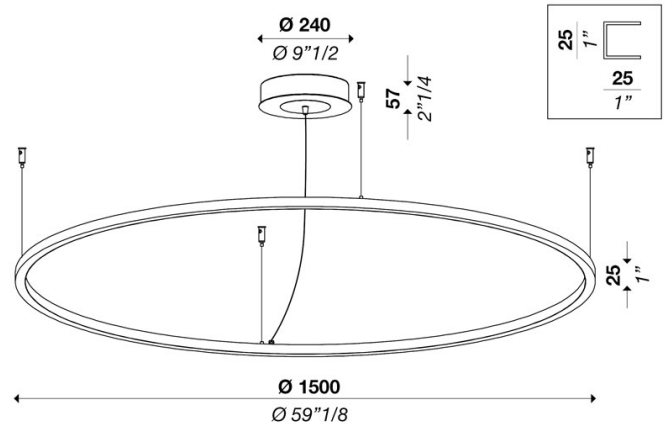

Technical data

Light source	LED
Circuit structure	LED strip
Light emission direction	diffused
Power	108 W
Source lumens	13500 lm
Source efficacy	125 lm/W
Energy class	E
Delivered lumens	9533 lm
Secondary	24 V
Colour temperature	3000 K / variants page 2
Colour rendering index	90 CRI / variants page 2
Standard Deviation of Colour Matching	3 SDCM
Safety class	I
Degree of protection	IP 20
Direct mounting on normally flammable surfaces	●
Operating temperature	+10° / +40°
CE	●
UL	○

Optional

Emergency mode	○
Motion sensor	○
Directional	○

Packing

Net weight	
Packaging 1	L1610 x W1620 x H130 mm / 14.6 kg
Packaging 2	
Packaging 3	
Packaging 4	
Packaging 5	

Structure

Material	aluminium
Finish	white / variants page 2

Diffuser

Material	polycarbonate
Finish	opal / variants page 2

Canopy

Size	240 mm - 9" 1/2 inch
Height	57 mm - 2" 1/4 inch
Ceiling mount	perpendicular / variants page 2

Electronics / Driver

Included	Yes
Quantity	2
Voltage	100-277V 50/60 Hz

Dimmable



Hanging cables

Stainless steel cables standard length (custom available)	2000 mm / 78" 3/4
Electric cable standard length (custom available)	2500 mm/100"

Warranty

Duration	2 years
----------	---------





CIRCUS round S1500 v2 DALI 100-277V

ver. 20200404_Rev_0





year: **2015**
 code: **2730331S10100**
 type: **hanging lamp**
 application: **indoor**

Available variants







Colour temperature

2700 k	3000 k	3500 k	4000 k	custom
				
<input type="radio"/>	<input checked="" type="radio"/>	<input type="radio"/>	<input checked="" type="radio"/>	<input checked="" type="radio"/>





Colour rendering index

CRI 80	CRI 90	CRI 95	custom
			
<input type="radio"/>	<input checked="" type="radio"/>	<input type="radio"/>	<input checked="" type="radio"/>





Structure finish

gold / brass	matt white	matt black	embossed white	embossed black	custom
					
<input checked="" type="radio"/>	<input type="radio"/>	<input checked="" type="radio"/>	<input type="radio"/>	<input type="radio"/>	<input checked="" type="radio"/>

Diffuser / Optical

opal	transparent	transparent prismatic	satin	custom
				
<input checked="" type="radio"/>	<input type="radio"/>	<input checked="" type="radio"/>	<input type="radio"/>	<input checked="" type="radio"/>

Ceiling Mount

direct	perpendicular	conical	remote driver	custom
				
<input type="radio"/>	<input checked="" type="radio"/>	<input checked="" type="radio"/>	<input type="radio"/>	<input checked="" type="radio"/>

CIRCUS round S1500 v2 DALI 100-277V

ver. 20200404_Rev_0

year: **2015**
code: **2730331S10100**
type: **hanging lamp**
application: **indoor**

Lighting features	
Source lumens	13500 lm
Source efficacy	125 lm/W
Consumption	123 W
Delivered lumens	9533 lm
Luminaire efficacy	78 lm/W
Secondary voltage	24 V
Colour temperature	3000 K / variants page 2
Colour rendering index	Array
Standard Deviation of Colour Matching	3 SDCM

LED life / Failure ratio	
LED life cycle	50000 h

UGR	
X=4H / Y=8H	
Reflection factor	
UGR transversal	
UGR axial	

Photometric 1

H 0.5m	d 5.67	E(0°):3181.9lx E(C0):25.1lx
H 1.0m	d 11.34	E(0°):795.5lx E(C0):6.3lx
H 1.5m	d 17.01	E(0°):353.5lx E(C0):2.8lx
H 2.0m	d 22.69	E(0°):198.9lx E(C0):1.6lx
H 2.5m	d 28.36	E(0°):127.3lx E(C0):1.0lx
H 3.0m	d 34.03	E(0°):88.4lx E(C0):0.7lx

Photometric 2

