

RITMO S1800 DALI 0_1-10V 100-277V

ver. 20200911_Rev_0

year: 2020
code: 2570301S80000
type: hanging lamp
application: indoor

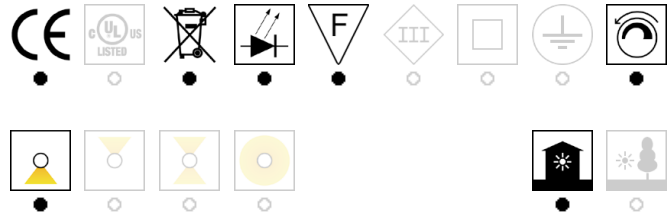

Technical drawing

Size ref. image mm - inch

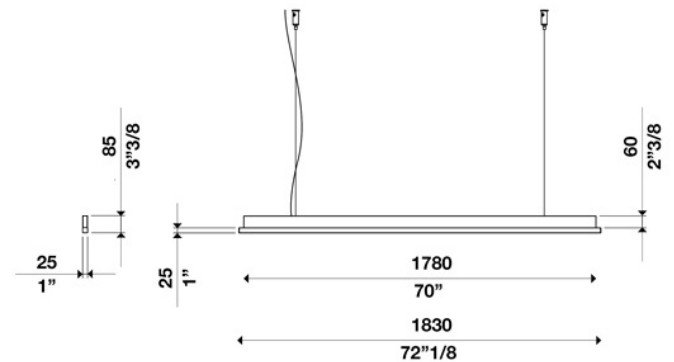

Technical data	
Light source	LED
Circuit structure	LED strip
Light emission direction	downward
Power	46 W
Source lumens	6440 lm
Source efficacy	142 lm/W
Consumption	54 W
Delivered lumens	
Luminaire efficacy	lm/W
Secondary	24 V
Colour temperature	3000 K / variants page 2
Colour rendering index	80 CRI / variants page 2
Standard Deviation of Colour Matching	3 SDCM
Energy class	A
Safety class	I
Degree of protection	IP 20
Direct mounting on normally flammable surfaces	●
Operating temperature	+10° / +40°
CE	●
UL	○
Optional	
Emergency mode	○
Motion sensor	○
Directional	○
Packing	
Net weight	
Packaging 1	
Packaging 2	
Packaging 3	
Packaging 4	
Packaging 5	

Structure						
Material	aluminium					
Finish	white / variants page 2					
Diffuser						
Material	polycarbonate					
Finish	opal / variants page 2					
Canopy						
Diameter (Ø)	90 mm - 3" 1/2 inch					
Height	30 mm - 1" 1/8 inch					
Ceiling mount	perpendicular / variants page 2					
Electronics / Driver						
Included	Yes					
Quantity	1					
Voltage	100-277V 50/60 Hz					
Dimmable						
ON/OFF	PUSH	0-10V	1-10V	CUT PHASE	Bluetooth	DALI
○	○	●	●	○	○	●
Hanging cables						
Stainless steel cables standard length (custom available)	2000 mm / 78" 3/4					
Electric cable standard length (custom available)	2500 mm/100"					
Warranty						
Duration	2 years					







RITMO S1800 DALI 0_1-10V 100-277V

ver. 20200911_Rev_0



year: **2020**
 code: **2570301S80000**
 type: **hanging lamp**
 application: **indoor**

Available versions







Colour temperature

2700K	3000K	3500K	4000K	5000K	LED bulb	custom
						
<input checked="" type="radio"/>	<input checked="" type="radio"/>	<input type="radio"/>	<input checked="" type="radio"/>	<input type="radio"/>	<input type="radio"/>	<input checked="" type="radio"/>





Colour rendering index

		
CRI 80	CRI 90	CRI 95
<input checked="" type="radio"/>	<input checked="" type="radio"/>	<input type="radio"/>





Structure finish

black	white	polished aluminium	brass	titanium	wood	custom
						
<input checked="" type="radio"/>	<input checked="" type="radio"/>	<input type="radio"/>	<input checked="" type="radio"/>	<input type="radio"/>	<input type="radio"/>	<input checked="" type="radio"/>

Diffuser finish

opal	opal prismatic	transparent	transparent prismatic	satin
				
<input checked="" type="radio"/>	<input type="radio"/>	<input checked="" type="radio"/>	<input checked="" type="radio"/>	<input type="radio"/>

Ceiling mount

direct	perpendicular	conical	custom
			
<input type="radio"/>	<input checked="" type="radio"/>	<input checked="" type="radio"/>	<input checked="" type="radio"/>