

RITMO W2300 upright DALI 0_1-10V 100-277V

ver. 20200911_Rev_0

year: 2020
code: 2570103S80000
type: wall lamp
application: indoor

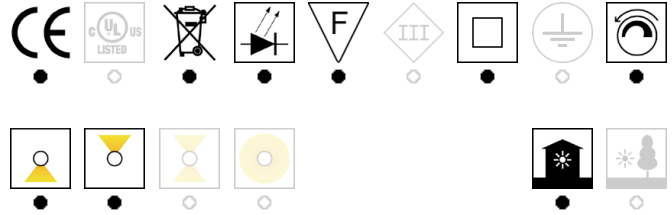

Technical drawing

Size ref. image mm - inch

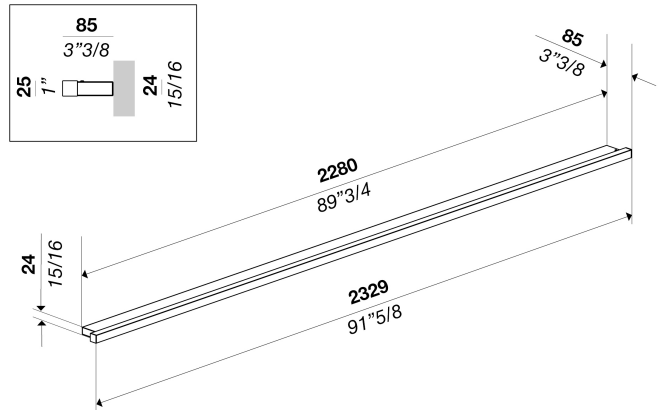

Technical data

Light source	LED
Circuit structure	LED strip
Light emission direction	indirect
Power	58 W
Source lumens	8220 lm
Source efficacy	142 lm/W
Consumption	69 W
Delivered lumens	
Luminaire efficacy	lm/W
Secondary	24 V
Colour temperature	3000 K / variants page 2
Colour rendering index	80 CRI / variants page 2
Standard Deviation of Colour Matching	3 SDCM
Energy class	A
Safety class	II
Degree of protection	IP 20
Direct mounting on normally flammable surfaces	●
Operating temperature	+10° / +40°
CE	●
UL	○

Optional	
Emergency mode	○
Motion sensor	○
Directional	○

Packing

Net weight	
Packaging 1	
Packaging 2	
Packaging 3	
Packaging 4	
Packaging 5	

Structure

Material	aluminium
Finish	white / variants page 2

Diffuser

Material	polycarbonate
Finish	opal / variants page 2

Canopy

Diameter (Ø)	○
Height	○
Ceiling mount	direct

Electronics / Driver

Included	Yes
Quantity	1
Voltage	100-277V 50/60 Hz

Dimmable

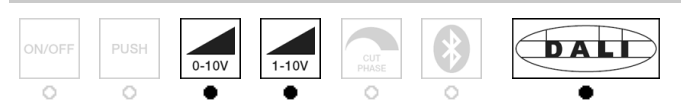

Hanging cables

Stainless steel cables standard length (custom available)	○
Electric cable standard length (custom available)	-

Warranty

Duration	2 years
----------	---------







RITMO W2300 upright DALI 0_1-10V 100-277V

ver. 20200911_Rev_0



year: **2020**
 code: **2570103S80000**
 type: **wall lamp**
 application: **indoor**

Available versions







Colour temperature

2700K	3000K	3500K	4000K	5000K	LED bulb	custom
						
<input checked="" type="radio"/>	<input checked="" type="radio"/>	<input type="radio"/>	<input checked="" type="radio"/>	<input type="radio"/>	<input type="radio"/>	<input checked="" type="radio"/>





Colour rendering index

CRI 80	CRI 90	CRI 95
		
<input checked="" type="radio"/>	<input checked="" type="radio"/>	<input type="radio"/>





Structure finish

black	white	polished aluminium	brass	titanium	wood	custom
						
<input checked="" type="radio"/>	<input checked="" type="radio"/>	<input type="radio"/>	<input checked="" type="radio"/>	<input type="radio"/>	<input type="radio"/>	<input checked="" type="radio"/>

Diffuser finish

opal	opal prismatic	transparent	transparent prismatic	satin
				
<input checked="" type="radio"/>	<input type="radio"/>	<input checked="" type="radio"/>	<input checked="" type="radio"/>	<input type="radio"/>

Ceiling mount

direct	perpendicular	conical	custom
			
<input type="radio"/>	<input checked="" type="radio"/>	<input checked="" type="radio"/>	<input checked="" type="radio"/>