

# KLOKKE S350 DALI 220V

ver. 20200404\_Rev\_0

year: 2018  
code: 2270303E10000  
type: hanging lamp  
application: indoor

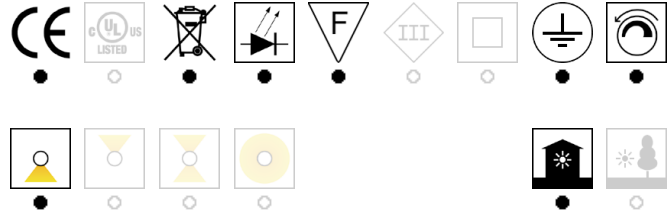

**Technical drawing**  
Size ref. image mm - inch

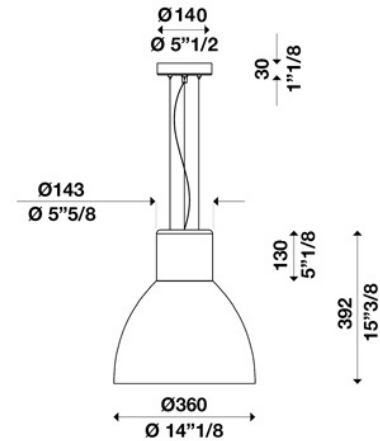

**Technical data**

Light source	LED
Circuit structure	LED module G4
Light emission direction	downward
Power	41 W
Source lumens	7000 lm
Source efficacy	171 lm/W
Consumption	45 W
Delivered lumens	3056 lm
Luminaire efficacy	68 lm/W
Secondary	1200mA
Colour temperature	3000 K / variants page 2
Colour rendering index	80 CRI / variants page 2
Standard Deviation of Colour Matching	3 SDCM
Energy class	A
Safety class	I
Degree of protection	IP 20
Direct mounting on normally flammable surfaces	●
Operating temperature	+10° / +40°
CE	●
UL	○

**Optional**

Emergency mode	○
Motion sensor	○
Directional	○

**Packing**

Net weight	3.5 Kg
Packaging 1	460 x 460 x 460 mm / 5 kg
Packaging 2	
Packaging 3	
Packaging 4	
Packaging 5	

**Structure**

Material	aluminium
Finish	white / variants page 2

**Diffuser**

Material	polycarbonate
Finish	opal / variants page 2

**Canopy**

Diameter ( Ø )	140 mm - 5" 1/2 inch
Height	30 mm - 1" 1/8 inch
Ceiling mount	perpendicular / variants page 2

**Electronics / Driver**

Included	Yes
Quantity	1
Voltage	220-240V 50/60 Hz

**Dimmable**



**Hanging cables**

Stainless steel cables standard length (custom available)	2000 mm / 78" 3/4
Electric cable standard length (custom available)	2500 mm/100"

**Warranty**

Duration	2 years
----------	---------







# KLOKKE S350 DALI 220V

ver. 20200404\_Rev\_0

year: **2018**  
code: **2270303E10000**  
type: **hanging lamp**  
application: **indoor**

## Available versions







### Colour temperature

2700K	3000K	3500K	4000K	5000K	LED bulb	custom
						
<input type="radio"/>	<input checked="" type="radio"/>	<input type="radio"/>	<input checked="" type="radio"/>	<input type="radio"/>	<input type="radio"/>	<input type="radio"/>





### Colour rendering index

		
CRI 80	CRI 90	CRI 95
<input checked="" type="radio"/>	<input type="radio"/>	<input type="radio"/>





### Structure finish

black	white	polished aluminium	brass	titanium	wood	custom
						
<input checked="" type="radio"/>	<input checked="" type="radio"/>	<input type="radio"/>	<input checked="" type="radio"/>	<input checked="" type="radio"/>	<input type="radio"/>	<input checked="" type="radio"/>

### Diffuser finish

opal	opal prismatic	transparent	transparent prismatic	satin
				
<input checked="" type="radio"/>	<input checked="" type="radio"/>	<input type="radio"/>	<input checked="" type="radio"/>	<input type="radio"/>

### Ceiling mount

direct	perpendicular	conical	custom
			
<input type="radio"/>	<input checked="" type="radio"/>	<input checked="" type="radio"/>	<input checked="" type="radio"/>