

# KLOKKE S350 ON-OFF 220V

ver. 20200404\_Rev\_0

year: 2018  
code: 2270303E00000  
type: hanging lamp  
application: indoor

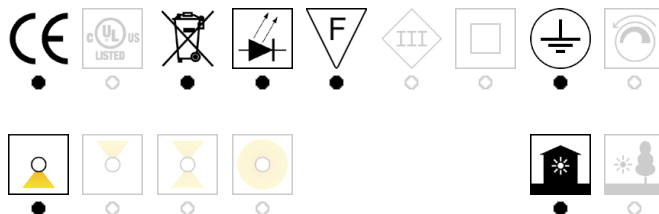

## Technical drawing

Size ref. image mm - inch

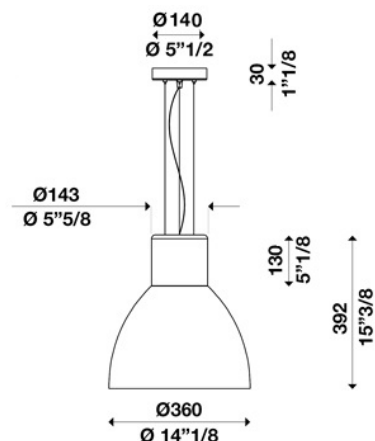

Technical data	
Light source	LED
Circuit structure	LED module G4
Light emission direction	downward
Power	41 W
Source lumens	7000 lm
Source efficacy	171 lm/W
Consumption	45 W
Delivered lumens	3056 lm
Luminaire efficacy	68 lm/W
Secondary	1200mA
Colour temperature	3000 K / variants page 2
Colour rendering index	80 CRI / variants page 2
Standard Deviation of Colour Matching	3 SDCM
Energy class	A
Safety class	I
Degree of protection	IP 20
Direct mounting on normally flammable surfaces	●
Operating temperature	+10° / +40°
CE	●
UL	○
Optional	
Emergency mode	○
Motion sensor	○
Directional	○
Packing	
Net weight	3.5 Kg
Packaging 1	460 x 460 x 460 mm / 5 kg
Packaging 2	
Packaging 3	
Packaging 4	
Packaging 5	

Structure	
Material	aluminium
Finish	white / variants page 2
Diffuser	
Material	polycarbonate
Finish	opal / variants page 2
Canopy	
Diameter ( $\varnothing$ )	140 mm - 5'' 1/2 inch
Height	30 mm - 1'' 1/8 inch
Ceiling mount	perpendicular / variants page 2

Electronics / Driver	
Included	Yes
Quantity	1
Voltage	220-240V 50/60 Hz

Dimmable	
ON/OFF	○
PUSH	○
0-10V	○
1-10V	○
CUT PHASE	○
Bluetooth	○
DALI	○

Hanging cables	
Stainless steel cables standard length (custom available)	2000 mm / 78'' 3/4
Electric cable standard length (custom available)	2500 mm/100''

Warranty	
Duration	2 years







# KLOKKE S350 ON-OFF 220V

ver. 20200404\_Rev\_0

year: **2018**  
 code: **2270303E00000**  
 type: **hanging lamp**  
 application: **indoor**

Available versions







Colour temperature

2700K	3000K	3500K	4000K	5000K	LED bulb	custom
						
<input type="radio"/>	<input checked="" type="radio"/>	<input type="radio"/>	<input checked="" type="radio"/>	<input type="radio"/>	<input type="radio"/>	<input type="radio"/>





Colour rendering index

		
CRI 80	CRI 90	CRI 95
<input checked="" type="radio"/>	<input type="radio"/>	<input type="radio"/>





Structure finish

black	white	polished aluminium	brass	titanium	wood	custom
						
<input checked="" type="radio"/>	<input checked="" type="radio"/>	<input type="radio"/>	<input checked="" type="radio"/>	<input checked="" type="radio"/>	<input type="radio"/>	<input checked="" type="radio"/>

Diffuser finish

opal	opal prismatic	transparent	transparent prismatic	satin
				
<input checked="" type="radio"/>	<input checked="" type="radio"/>	<input type="radio"/>	<input checked="" type="radio"/>	<input type="radio"/>

Ceiling mount

direct	perpendicular	conical	custom
			
<input type="radio"/>	<input checked="" type="radio"/>	<input checked="" type="radio"/>	<input checked="" type="radio"/>