

PIN W160 DALI 220V

ver. 20200404_Rev_0

year: 2014
code: 1710116E10000
type: wall lamp
application: indoor

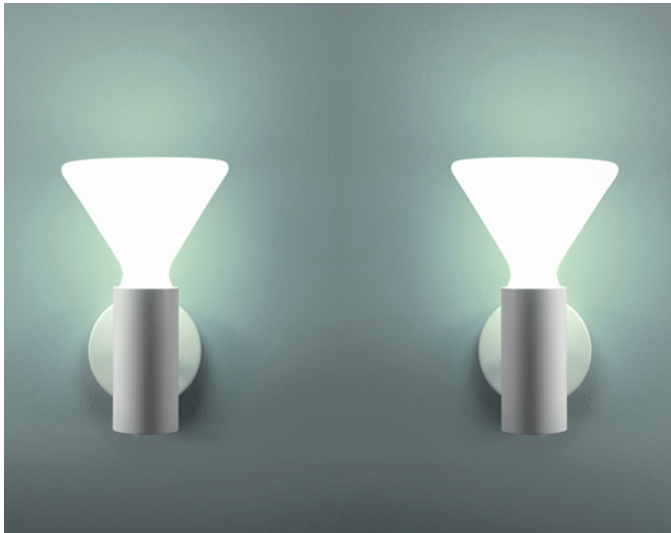
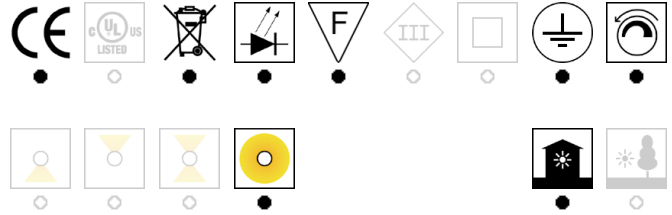

Technical drawing
Size ref. image mm - inch

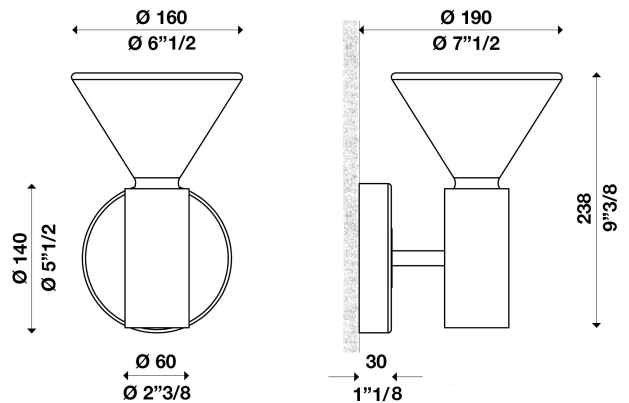

Technical data

| | |
|--|--------------------------|
| Light source | LED |
| Circuit structure | LED COB G7 |
| Light emission direction | diffused |
| Power | 9 W |
| Source lumens | 1406 lm |
| Source efficacy | 155 lm/W |
| Consumption | 12 W |
| Delivered lumens | 916 lm |
| Luminaire efficacy | 76 lm/W |
| Secondary | 350mA |
| Colour temperature | 3000 K / variants page 2 |
| Colour rendering index | 80 CRI / variants page 2 |
| Standard Deviation of Colour Matching | 3 SDCM |
| Energy class | A |
| Safety class | I |
| Degree of protection | IP 20 |
| Direct mounting on normally flammable surfaces | ● |
| Operating temperature | +10° / +40° |
| CE | ● |
| UL | ○ |
| Optional | |
| Emergency mode | ○ |
| Motion sensor | ○ |
| Directional | ○ |

Packing

| | |
|-------------|--|
| Net weight | |
| Packaging 1 | |
| Packaging 2 | |
| Packaging 3 | |
| Packaging 4 | |
| Packaging 5 | |

Structure

| | |
|----------|-------------------------|
| Material | aluminium |
| Finish | white / variants page 2 |

Diffuser

| | |
|----------|-------|
| Material | glass |
| Finish | white |

Electronics / Driver

| | |
|----------|-------------------|
| Included | Yes |
| Quantity | 1 |
| Voltage | 220-240V 50/60 Hz |

Dimmable



Hanging cables

| | |
|---|---|
| Stainless steel cables standard length (custom available) | ○ |
| Electric cable standard length (custom available) | - |

Warranty

| | |
|----------|---------|
| Duration | 2 years |
|----------|---------|







PIN W160 DALI 220V

ver. 20200404_Rev_0



year: **2014**
 code: **1710116E10000**
 type: **wall lamp**
 application: **indoor**

Available versions







Colour temperature

| | | | | | | |
|--|---|---|---|---|---|---|
| 2700K | 3000K | 3500K | 4000K | 5000K | LED bulb | custom |
|  |  |  |  |  |  |  |
| <input checked="" type="radio"/> | <input checked="" type="radio"/> | <input type="radio"/> | <input checked="" type="radio"/> | <input type="radio"/> | <input type="radio"/> | <input type="radio"/> |





Colour rendering index

| | | |
|---|--|--|
| CRI 80 | CRI 90 | CRI 95 |
|  |  |  |
| <input checked="" type="radio"/> | <input checked="" type="radio"/> | <input type="radio"/> |

Structure finish

| | | | | | | |
|--|---|---|---|---|---|---|
| black | white | polished aluminium | brass | titanium | wood | custom |
|  |  |  |  |  |  |  |
| <input checked="" type="radio"/> | <input checked="" type="radio"/> | <input checked="" type="radio"/> | <input checked="" type="radio"/> | <input checked="" type="radio"/> | <input type="radio"/> | <input checked="" type="radio"/> |

Diffuser finish

| | | | | |
|--|---|---|---|---|
| opal | opal prismatic | transparent | transparent prismatic | satin |
|  |  |  |  |  |
| <input checked="" type="radio"/> | <input type="radio"/> | <input type="radio"/> | <input type="radio"/> | <input type="radio"/> |