

GRUE F2000 DIMMER 100-240V

ver. 20200404_Rev_0

year: 2014
code: 1230601U70000
type: floor lamp
application: indoor

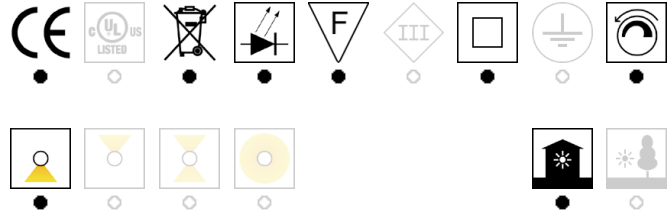

Technical drawing

Size ref. image mm - inch

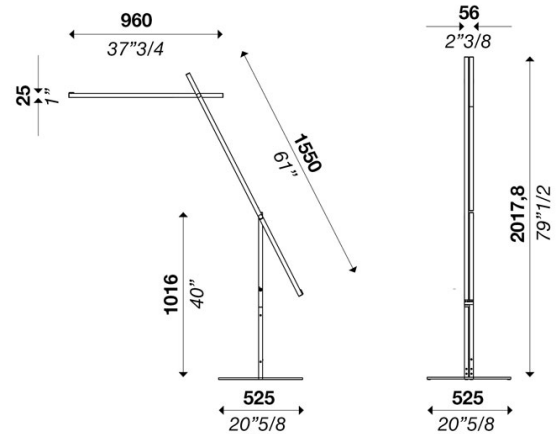

Technical data

Light source	LED
Circuit structure	LED strip
Light emission direction	downward
Power	17 W
Source lumens	2380 lm
Source efficacy	140 lm/W
Consumption	25 W
Delivered lumens	1980 lm
Luminaire efficacy	79 lm/W
Secondary	24 V
Colour temperature	3000 K / variants page 2
Colour rendering index	80 CRI / variants page 2
Standard Deviation of Colour Matching	3 SDCM
Energy class	A
Safety class	II
Degree of protection	IP 20
Direct mounting on normally flammable surfaces	●
Operating temperature	+10° / +40°
CE	●
UL	○

Optional	
Emergency mode	○
Motion sensor	○
Directional	●

Packing

Net weight	
Packaging 1	
Packaging 2	
Packaging 3	
Packaging 4	
Packaging 5	

Structure

Material	aluminium
Finish	white / variants page 2

Diffuser

Material	polycarbonate
Finish	opal / variants page 2

Electronics / Driver

Included	Yes
Quantity	1
Voltage	100-240V 50/60 Hz

Dimmable



Hanging cables

Stainless steel cables standard length (custom available)	○
Electric cable standard length (custom available)	-

Warranty

Duration	2 years
----------	---------







GRUE F2000 DIMMER 100-240V

ver. 20200404_Rev_0





year: **2014**
code: **1230601U70000**
type: **floor lamp**
application: **indoor**

Available variants

Colour temperature

2700 k	3000 k	3500 k	4000 k	bulb	custom
					
<input type="radio"/>	<input checked="" type="radio"/>	<input type="radio"/>	<input type="radio"/>	<input type="radio"/>	<input type="radio"/>







Colour rendering index

CRI 80	CRI 90	CRI 95	custom
			
<input type="radio"/>	<input checked="" type="radio"/>	<input type="radio"/>	<input type="radio"/>

Structure finish

gold / brass	champagne	gunmetal	beige	lead	naval brass	anodized brass	glossy night blue	sideral copper	blue 5020
									
<input checked="" type="radio"/>	<input type="radio"/>	<input type="radio"/>	<input type="radio"/>	<input type="radio"/>	<input type="radio"/>	<input type="radio"/>	<input type="radio"/>	<input type="radio"/>	<input type="radio"/>
matt white	matt black	embossed white	embossed black	titanium	manganese	ferrari red	mat blue	bronze	custom
									
<input checked="" type="radio"/>	<input checked="" type="radio"/>	<input type="radio"/>	<input type="radio"/>	<input type="radio"/>	<input type="radio"/>	<input type="radio"/>	<input type="radio"/>	<input type="radio"/>	<input type="radio"/>

Diffuser / Optical

opal	opal prismatic	transparent	transparent prismatic	satin	custom
					
<input type="radio"/>	<input type="radio"/>	<input type="radio"/>	<input checked="" type="radio"/>	<input type="radio"/>	<input type="radio"/>