

# RIGA S1300 0-10V 110V

ver. 20200404\_Rev\_0

year: 2015  
code: 1220301A20000  
type: hanging lamp  
application: indoor

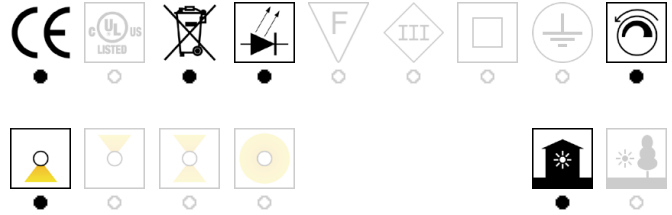

**Technical drawing**  
Size ref. image mm - inch

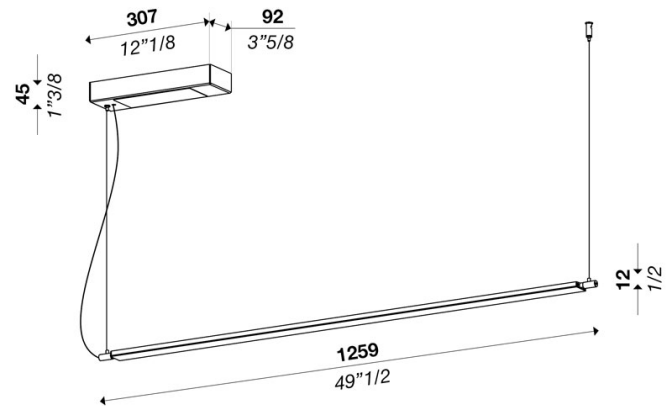

**Technical data**

Light source	LED
Circuit structure	LED module
Light emission direction	adjustable task lighting
Power	
Source lumens	
Source efficacy	
Consumption	
Delivered lumens	
Luminaire efficacy	
Secondary	
Colour temperature	
Colour rendering index	
Standard Deviation of Colour Matching	
Energy class	
Safety class	
Degree of protection	
Direct mounting on normally flammable surfaces	⊙
Operating temperature	+10° / +40°
CE	●
UL	⊙

**Optional**

Emergency mode	⊙
Motion sensor	⊙
Directional	●

**Packing**

Net weight	
Packaging 1	
Packaging 2	
Packaging 3	
Packaging 4	
Packaging 5	

**Structure**

Material	aluminium
Finish	white / variants page 2

**Diffuser**

Material	polycarbonate
Finish	opal / variants page 2

**Canopy**

Diameter ( Ø )	307 x 92 mm - 12" 1/8 x 3" 5/8 inch
Height	45 mm - 1" 3/4 inch
Ceiling mount	perpendicular / variants page 2

**Electronics / Driver**

Included	Yes
Quantity	1
Voltage	100-277V 50/60 Hz

**Dimmable**



**Hanging cables**

Stainless steel cables standard length (custom available)	2000 mm / 78" 3/4
Electric cable standard length (custom available)	2500 mm/100"

**Warranty**

Duration	2 years
----------	---------







# RIGA S1300 0-10V 110V

ver. 20200404\_Rev\_0

year: **2015**  
code: **1220301A20000**  
type: **hanging lamp**  
application: **indoor**

## Available versions







### Colour temperature

2700K	3000K	3500K	4000K	5000K	LED bulb	custom
						
<input type="radio"/>	<input checked="" type="radio"/>	<input type="radio"/>	<input checked="" type="radio"/>	<input type="radio"/>	<input type="radio"/>	<input type="radio"/>





### Colour rendering index

		
CRI 80	CRI 90	CRI 95
<input checked="" type="radio"/>	<input type="radio"/>	<input type="radio"/>





### Structure finish

black	white	polished aluminium	brass	titanium	wood	custom
						
<input checked="" type="radio"/>	<input checked="" type="radio"/>	<input type="radio"/>	<input checked="" type="radio"/>	<input type="radio"/>	<input type="radio"/>	<input checked="" type="radio"/>

### Diffuser finish

opal	opal prismatic	transparent	transparent prismatic	satin
				
<input checked="" type="radio"/>	<input type="radio"/>	<input type="radio"/>	<input checked="" type="radio"/>	<input checked="" type="radio"/>

### Ceiling mount

direct	perpendicular	conical	custom
			
<input type="radio"/>	<input checked="" type="radio"/>	<input type="radio"/>	<input checked="" type="radio"/>