

LOTUS S530 ON-OFF 110V

ver. 20200404_Rev_0

year: 2012
code: 0900302A00601
type: hanging lamp
application: indoor

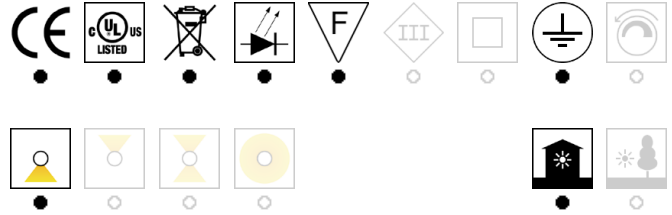

Technical drawing

Size ref. image mm - inch

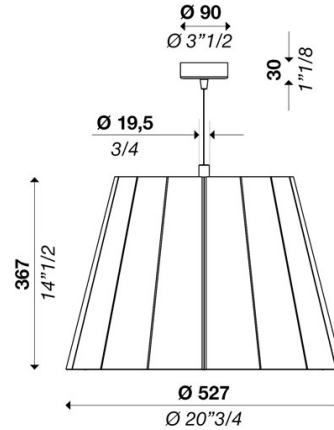

Technical data

Light source	LED bulb
Circuit structure	LED bulb
Light emission direction	downward
Power	1x MAX 20W E26
Source lumens	
Source efficacy	
Consumption	1x MAX 20W E26
Delivered lumens	
Luminaire efficacy	
Secondary	
Colour temperature	
Colour rendering index	
Standard Deviation of Colour Matching	
Energy class	A
Safety class	I
Degree of protection	IP 20
Direct mounting on normally flammable surfaces	●
Operating temperature	+10° / +40°
CE	●
UL	●

Optional

Emergency mode	○
Motion sensor	○
Directional	○

Packing

Net weight	
Packaging 1	
Packaging 2	
Packaging 3	
Packaging 4	
Packaging 5	

Structure

Material	steel
Finish	white / variants page 2

Diffuser

Material	
Finish	

Canopy

Diameter (Ø)	90 mm - 3" 1/2 inch
Height	30 mm - 1" 1/8 inch
Ceiling mount	direct / variants page 2

Lampshade

Material	Dibond®
Finish	white / variants page 2

Electronics / Driver

Included	No
Quantity	
Voltage	100-120V 60 Hz

Dimmable



Hanging cables

Stainless steel cables standard length (custom available)	2000 mm / 78" 3/4
Electric cable standard length (custom available)	2500 mm/100" fabric-textile-tessile

Warranty

Duration	2 years
----------	---------

LOTUS S530 ON-OFF 110V

ver. 20200404_Rev_0

year: **2012**
code: **0900302A00601**
type: **hanging lamp**
application: **indoor**

Available variants

Colour temperature

2700 k



3000 k



3500 k



4000 k



bulb



custom



Structure finish

matt white



polished



custom



Ceiling Mount

direct



custom

